

依玛

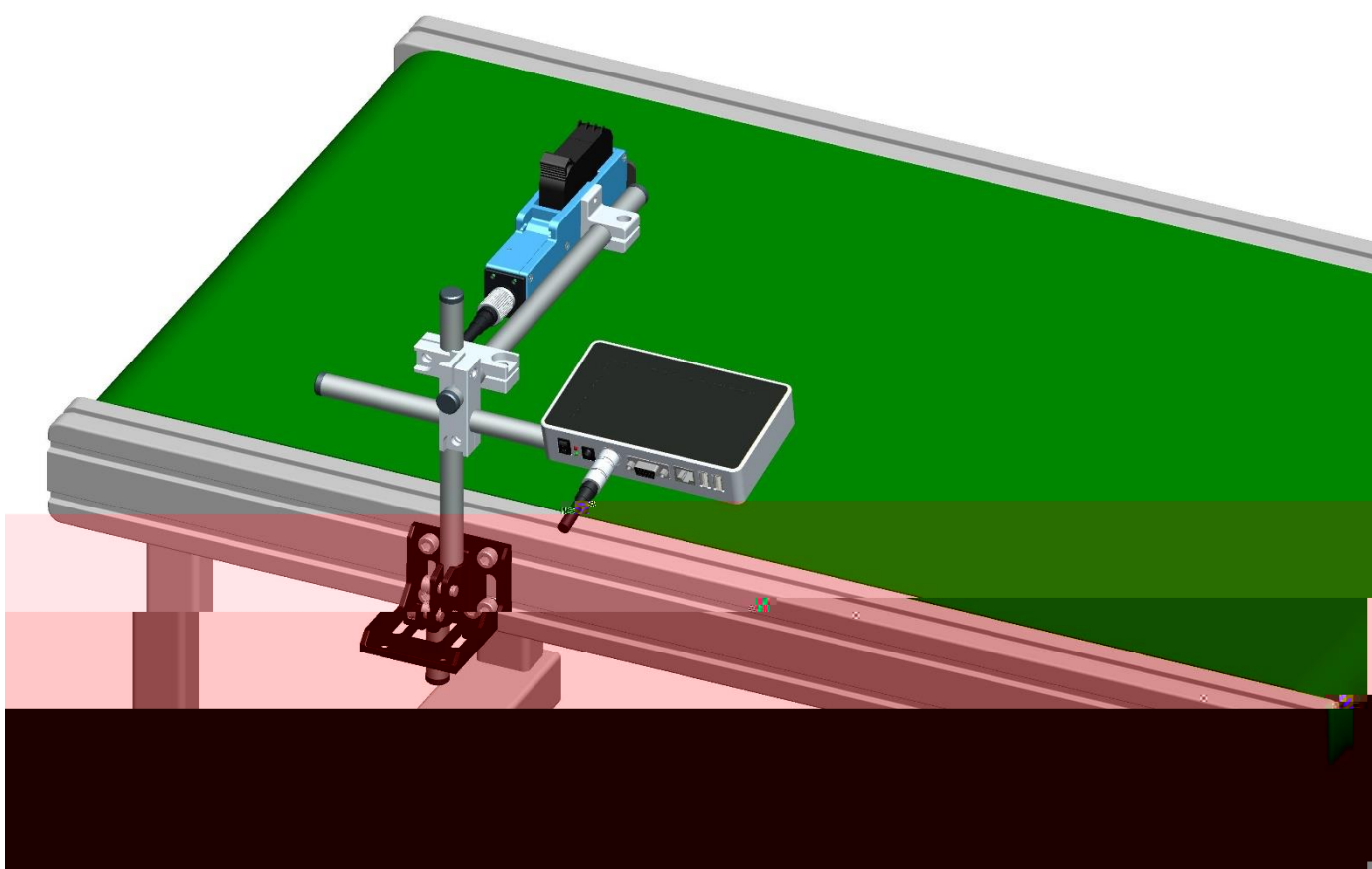



!





2.1

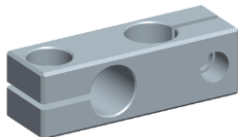
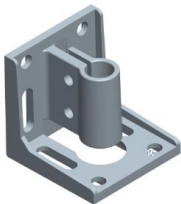
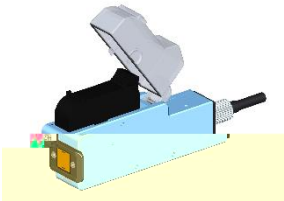
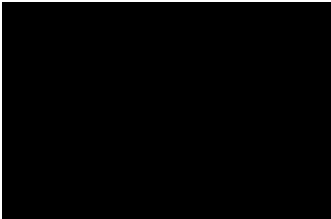

2.2

2.2.1

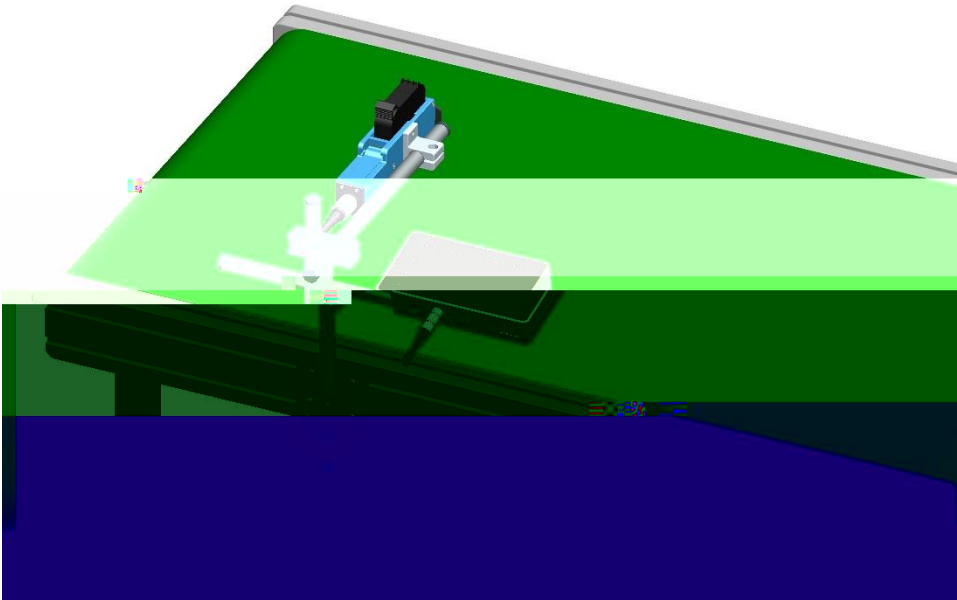

2.2.2

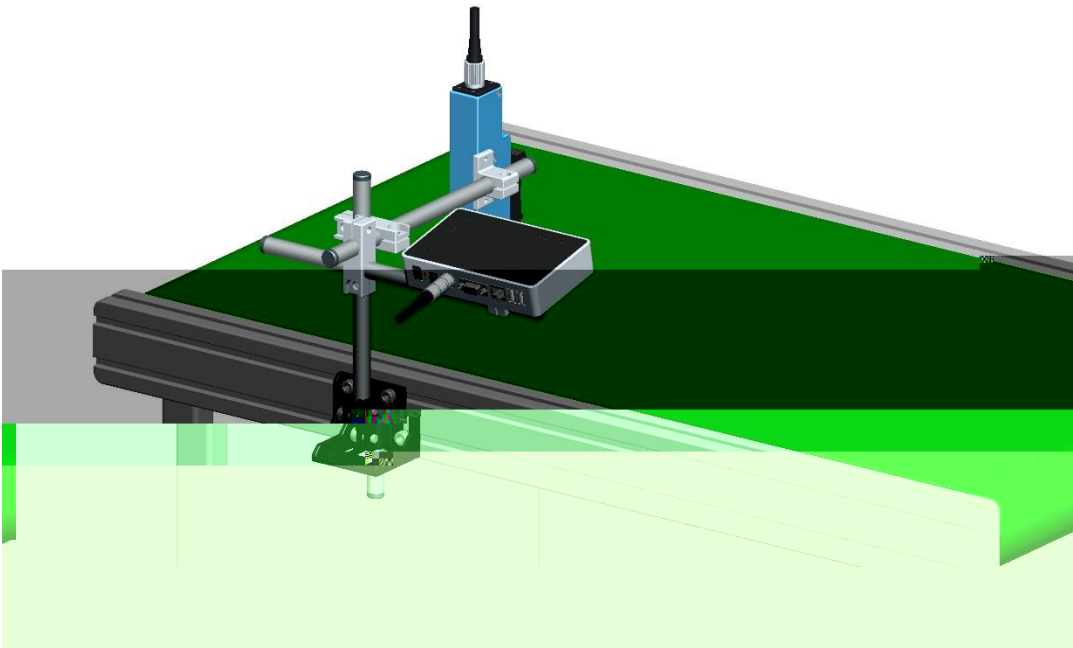

2.2.3

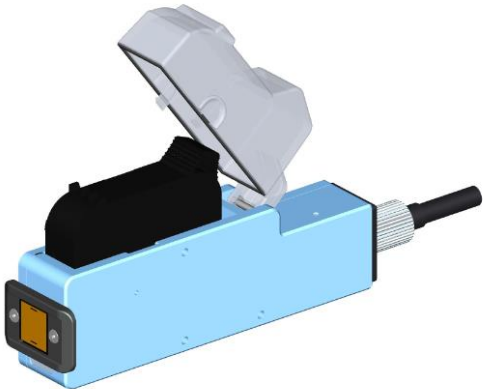
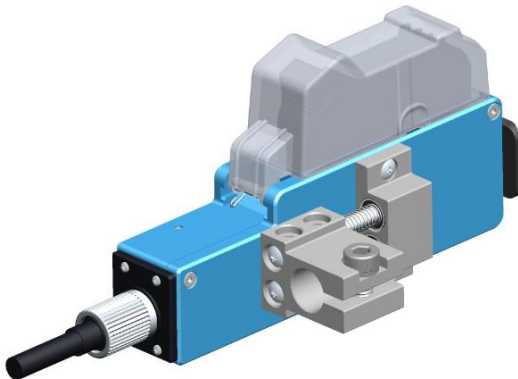

3.1

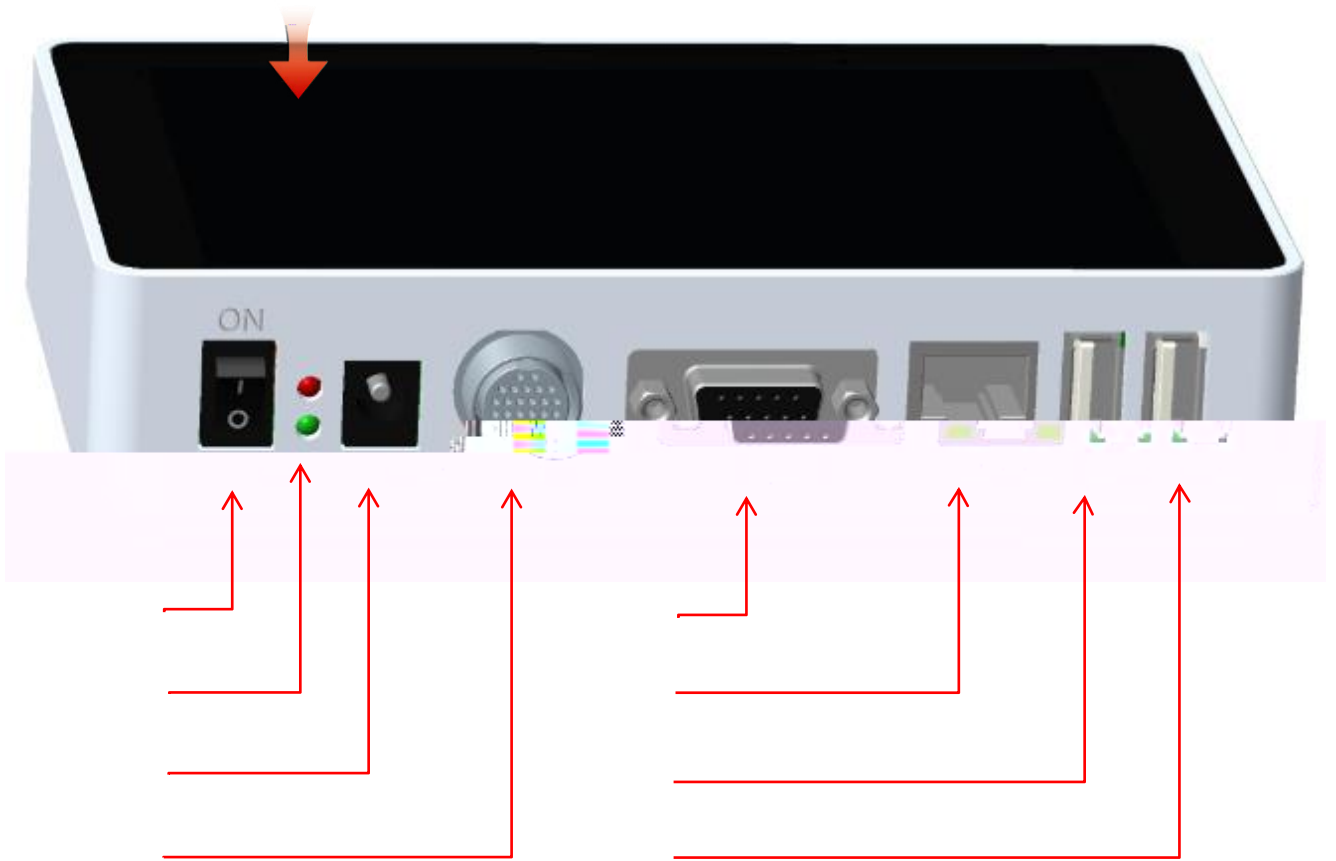

3.2

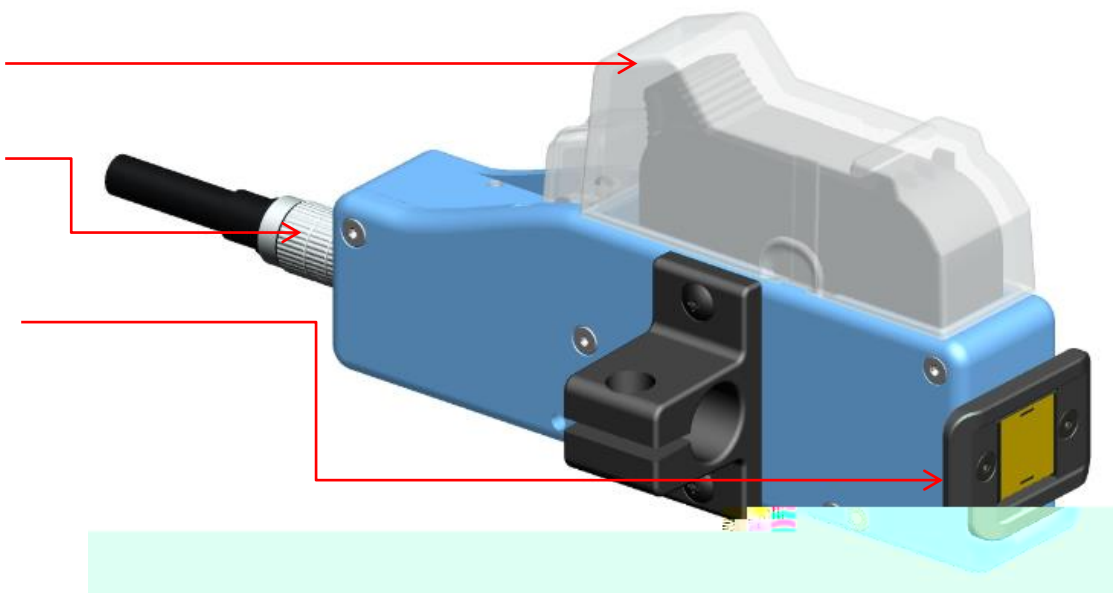







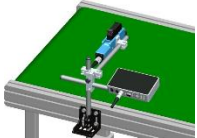

3.3

A.

B.

C.

4.1

4.2

4.3

5.1

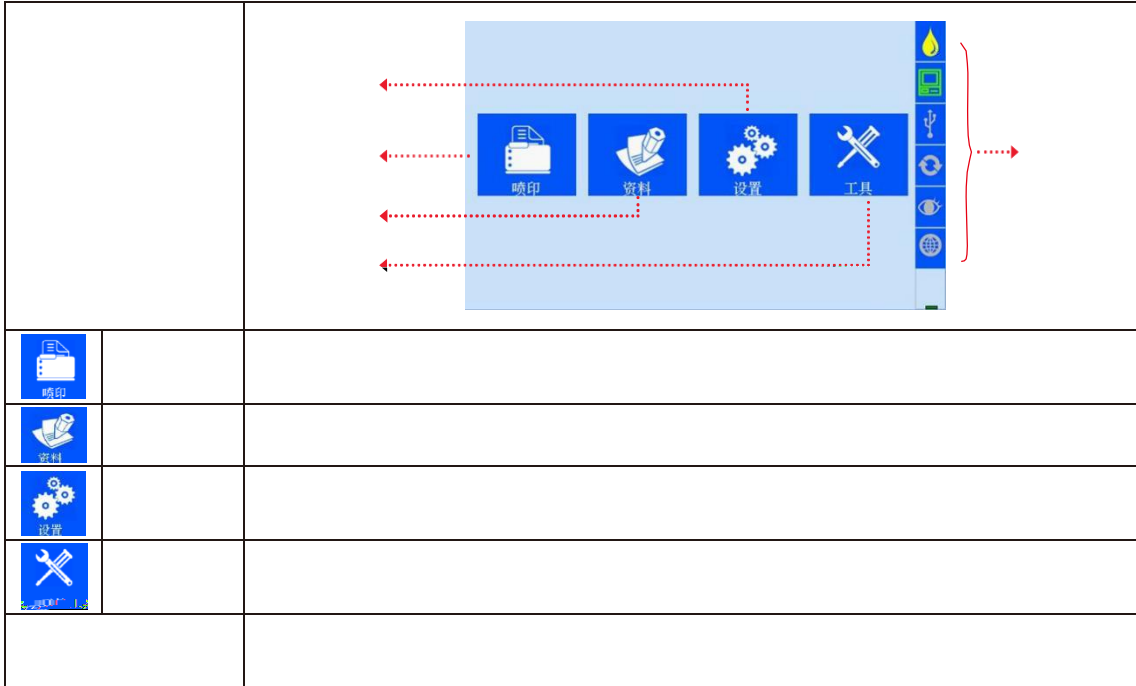

5.2

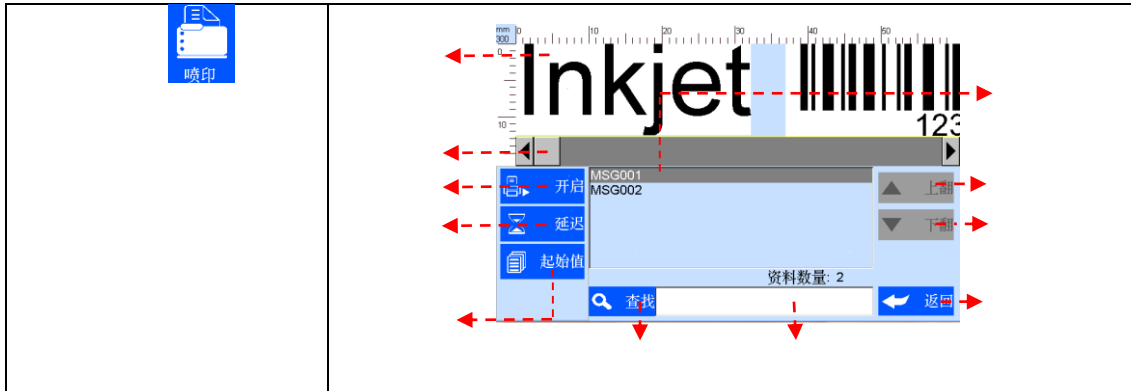

5.2.1



5.2.2

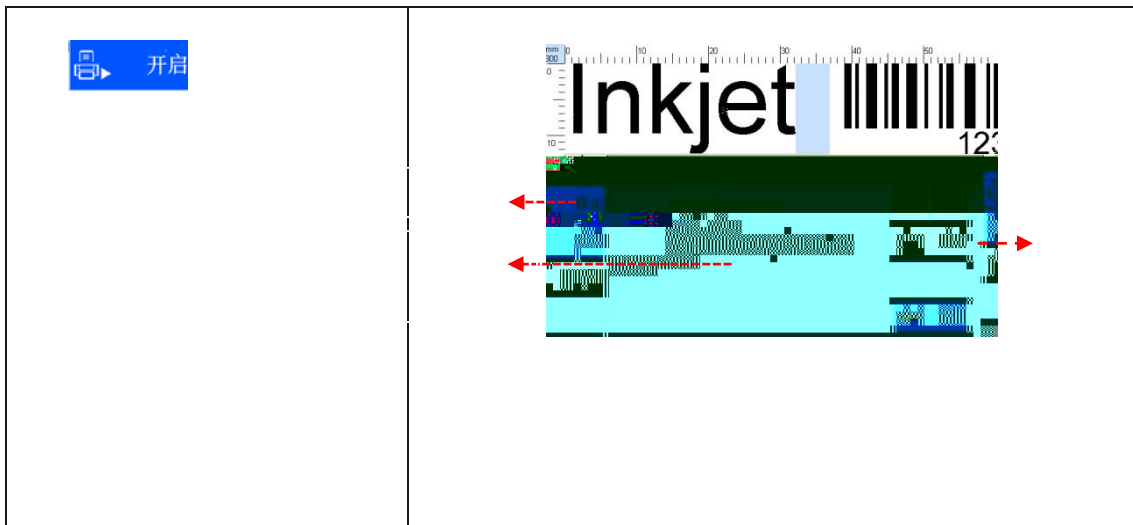

/

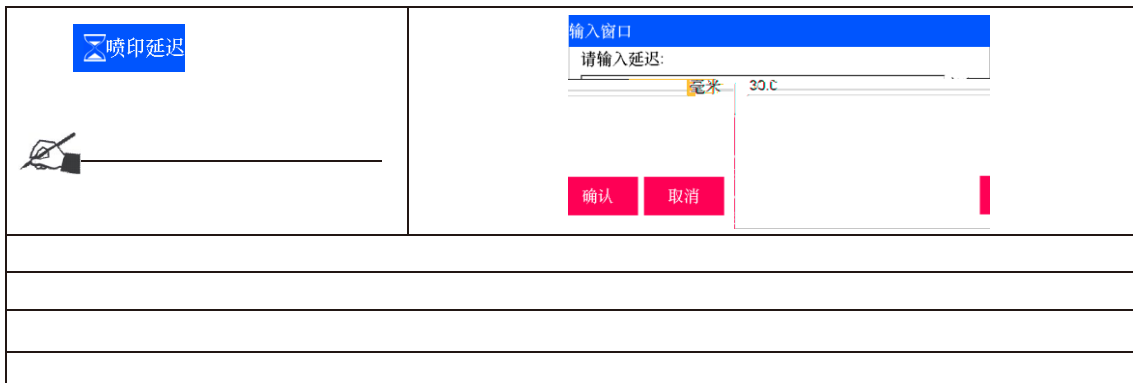

5.2.3



5.2.4

<p> 起始值</p> <p>DEC</p>	<p>起始值设置</p> <p>当前值 重复索引值</p> <p>计数器 1: 1</p> <p>计数器 2: 1</p> <p>字符串1</p> <p>STRING1</p> <p>确认 取消</p>
<p></p>	<p>起始值设置</p> <p>当前值 重复索引值</p> <p>DEC</p> <p>字符串1</p> <p>确认 取消</p> <p>所有普通计数器将一样</p> <p>1 9999</p> <p>1 0 DEC</p> <p>确认 取消</p>

5.2.5

<p>点击  停止</p>
--

5.3

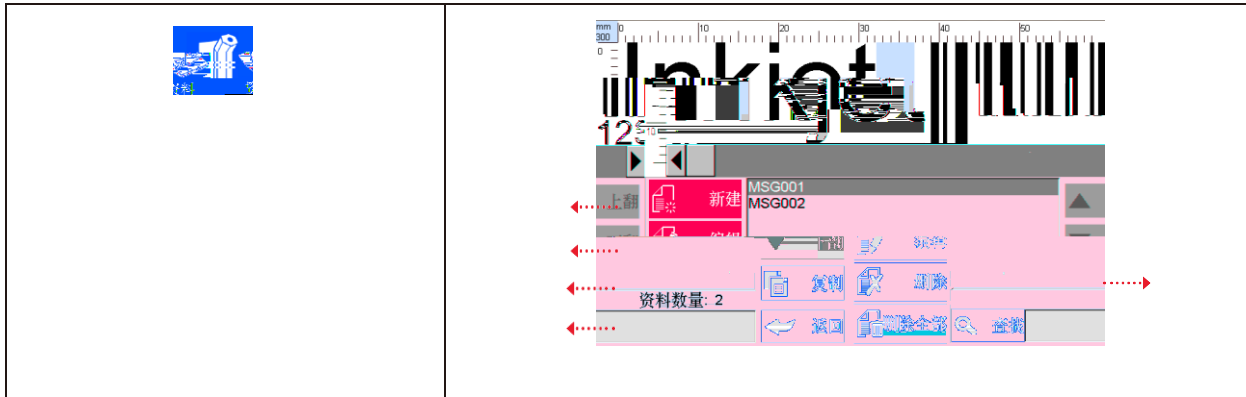

5.3.1 /

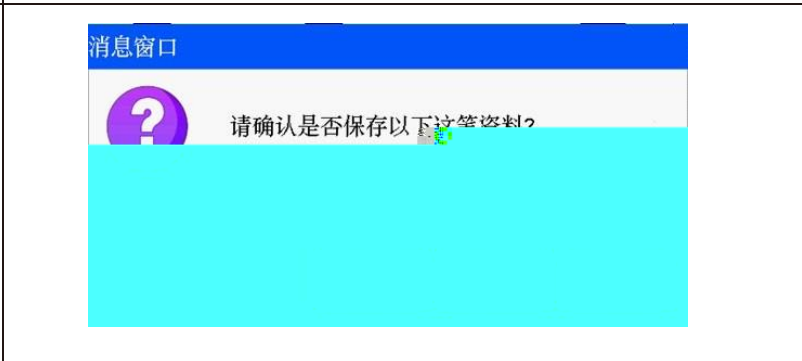
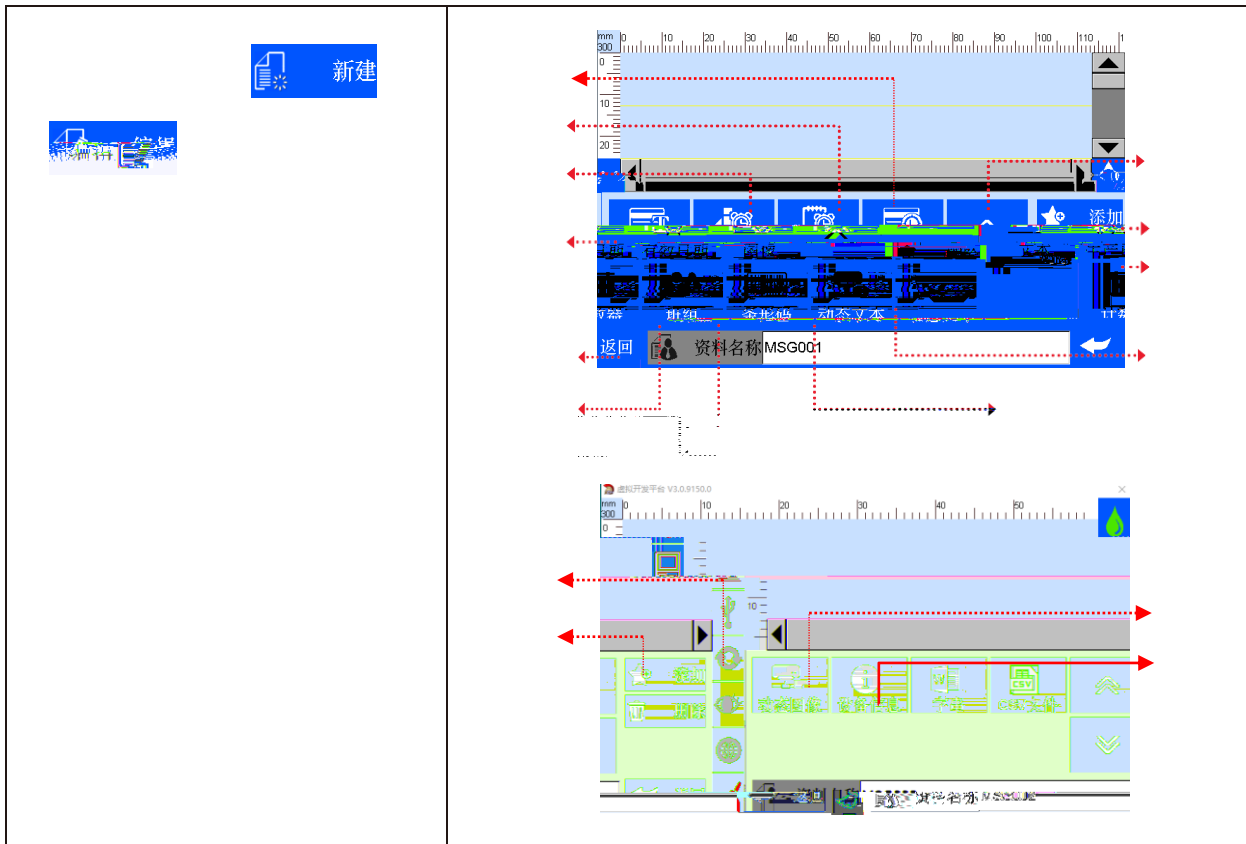

5.3.2

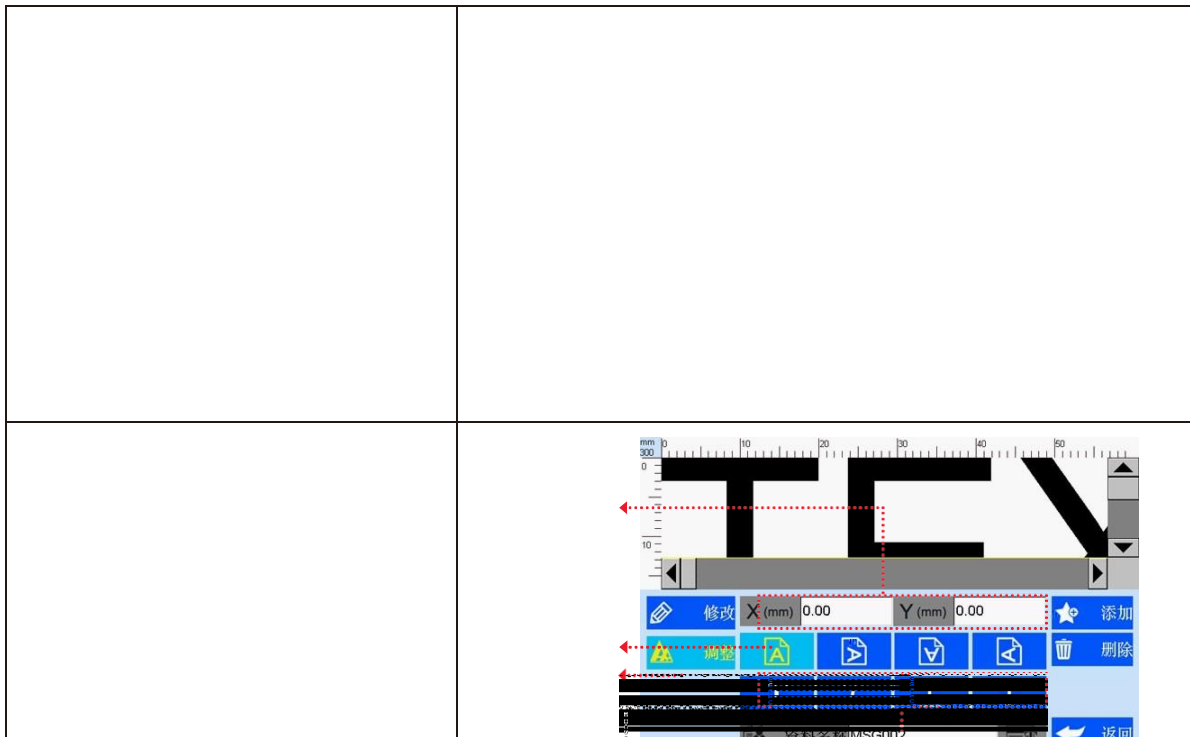

5.3.5



5.3.7

5.3.8

 <p>条形码</p>	

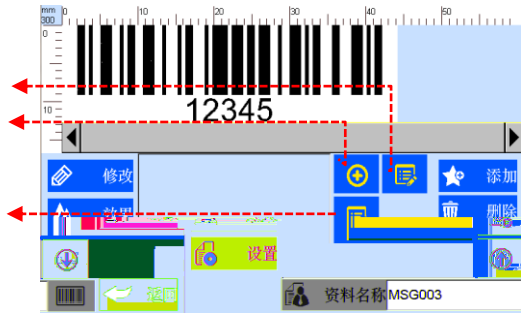

5.3.9

5.3.10

5.3.11

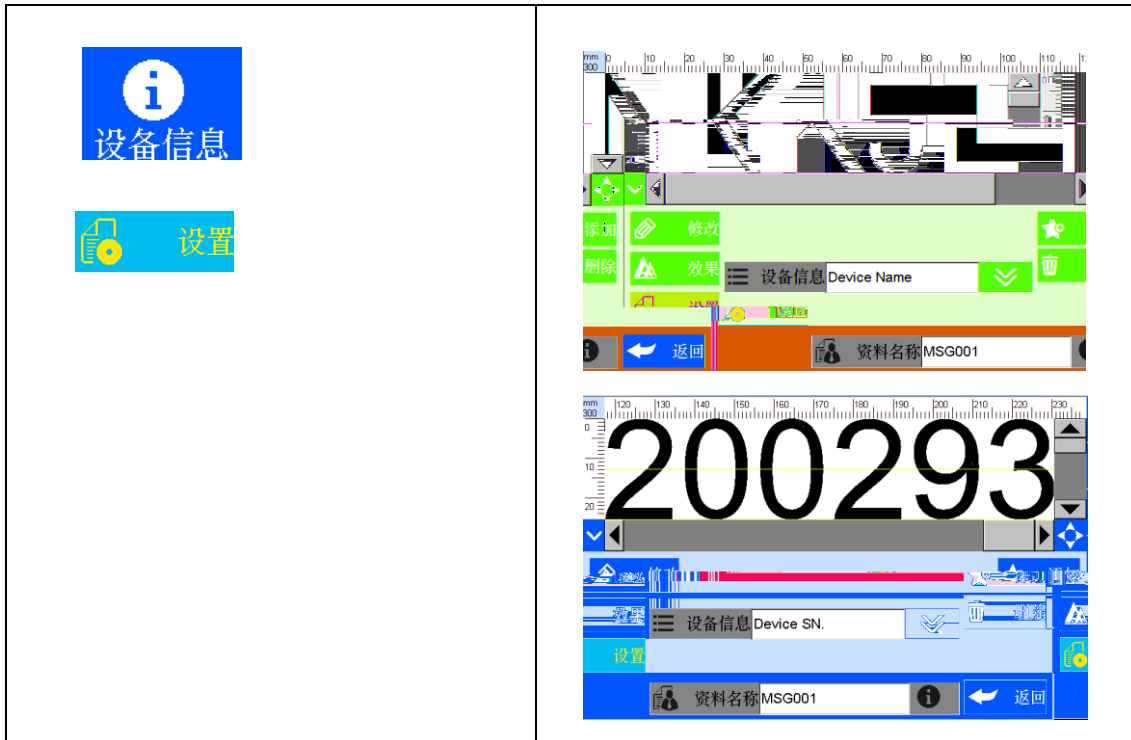

5.3.12

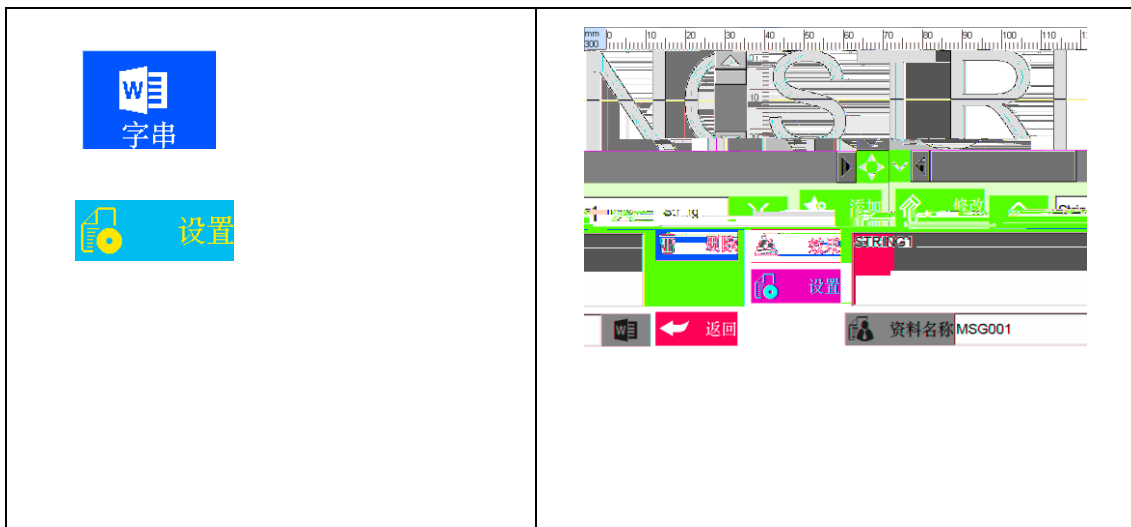

5.3.13 CSV

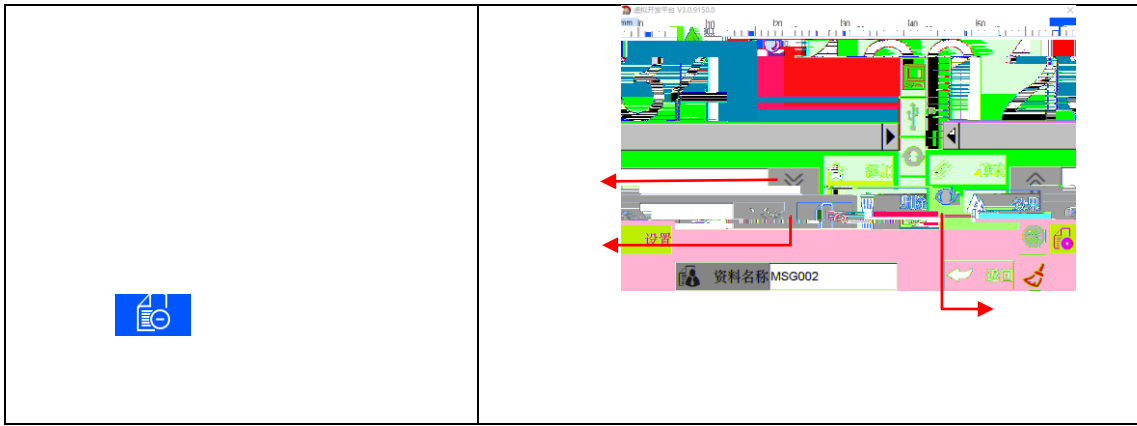

5.3.14 / /



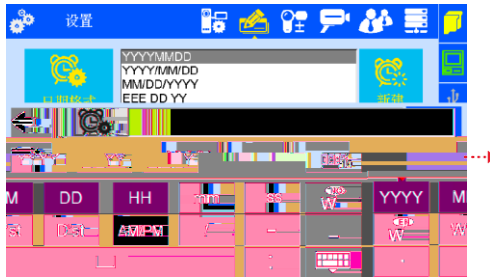

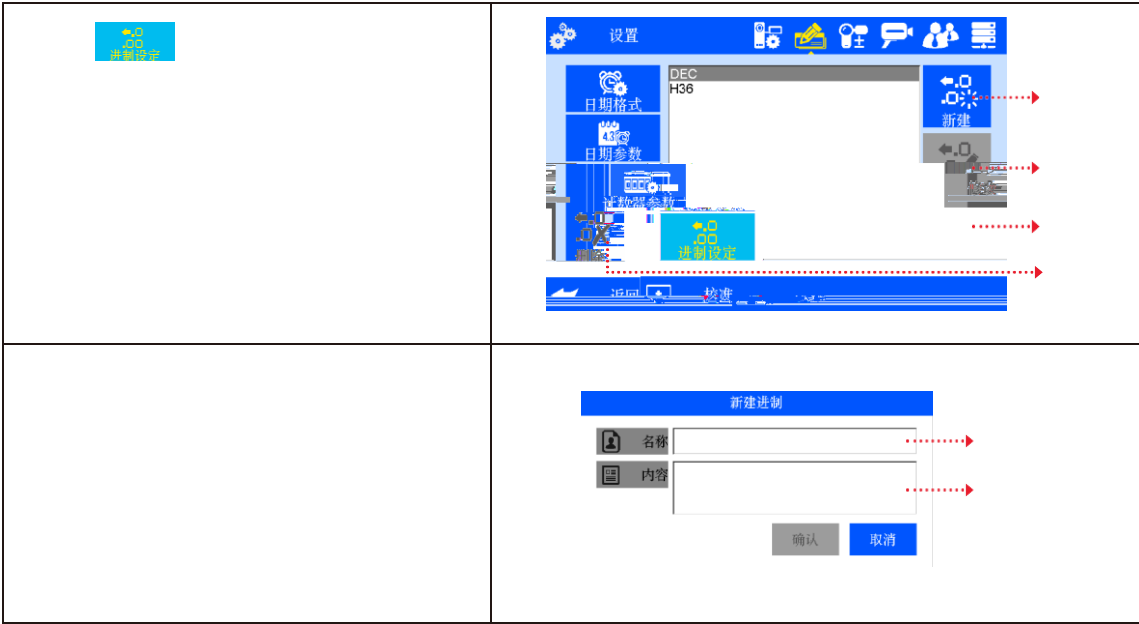

5.4.3

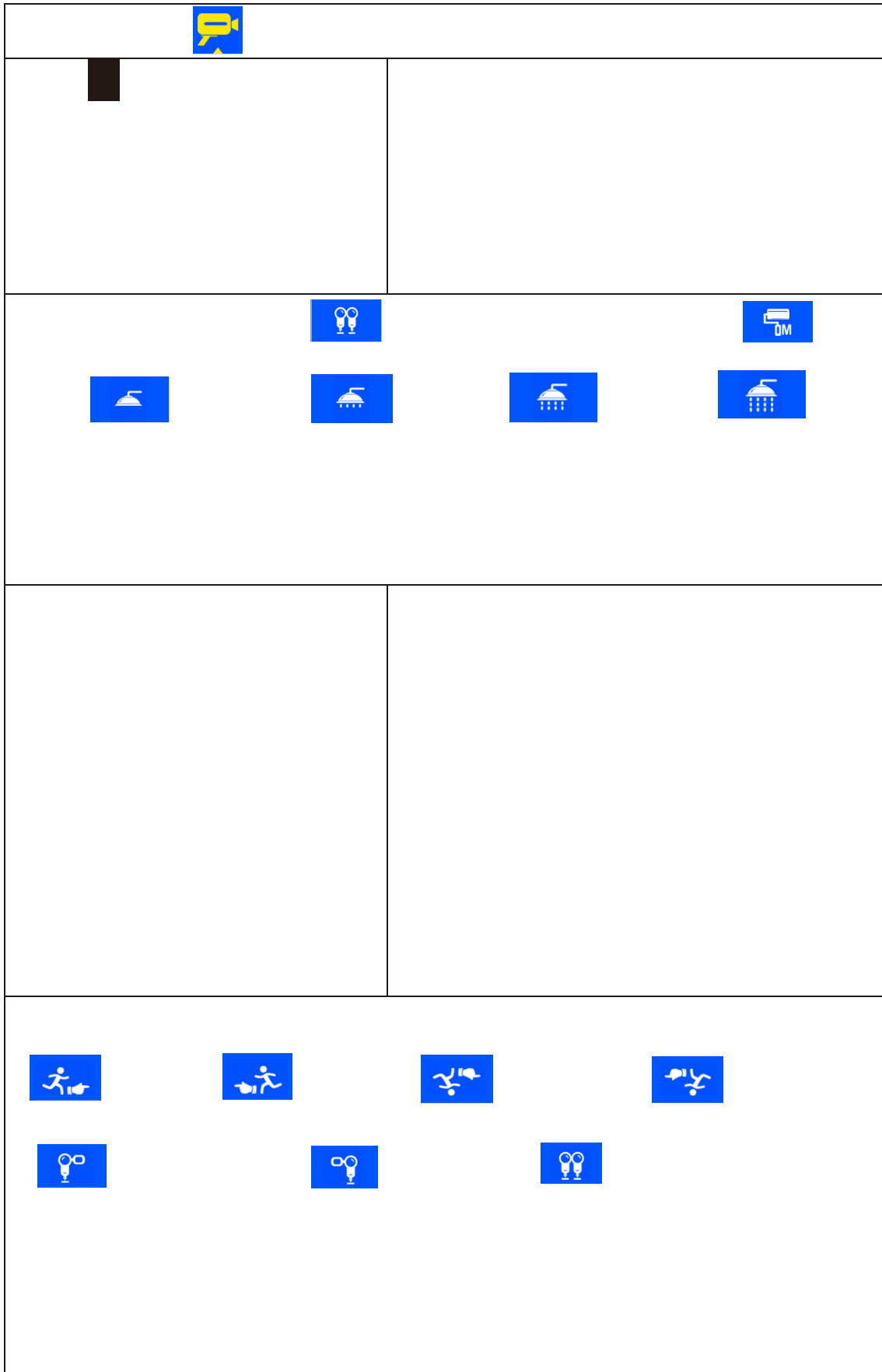

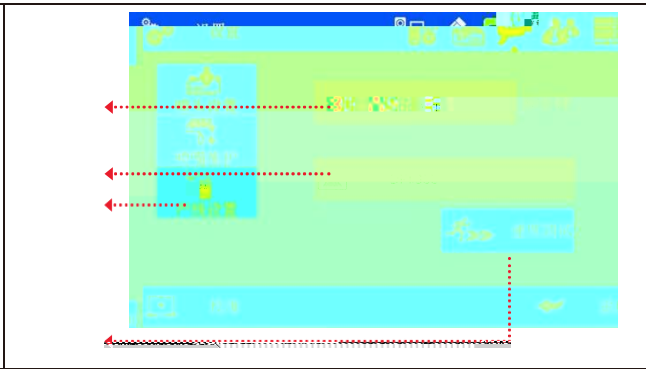
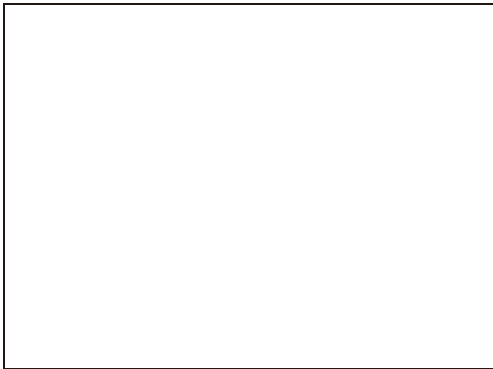





保存

取消

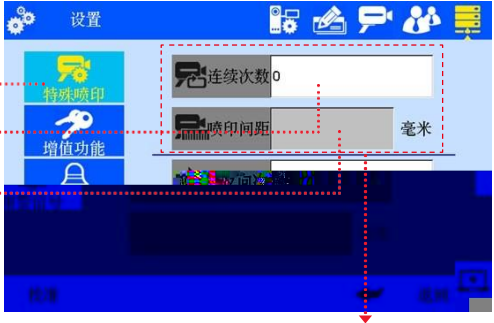

5.4.6

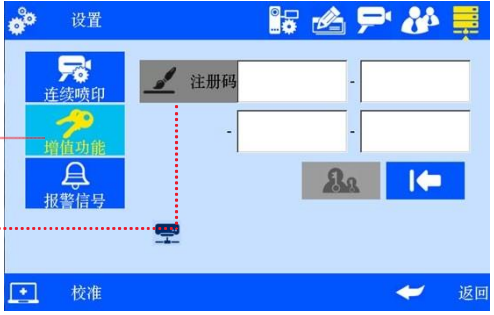
  	 <p>设置</p> <p>连续次数 0</p> <p>喷印间距 毫米</p> <p>特殊喷印</p> <p>增值功能</p> <p>校准</p>
	 <p>设置</p> <p>连续次数 0</p> <p>喷印间距 毫米</p> <p>特殊喷印</p> <p>增值功能</p> <p>校准</p>
 增值功能	 <p>设置</p> <p>注册码</p> <p>连续喷印</p> <p>增值功能</p> <p>报警信号</p> <p>校准</p> <p>返回</p>



.4.7

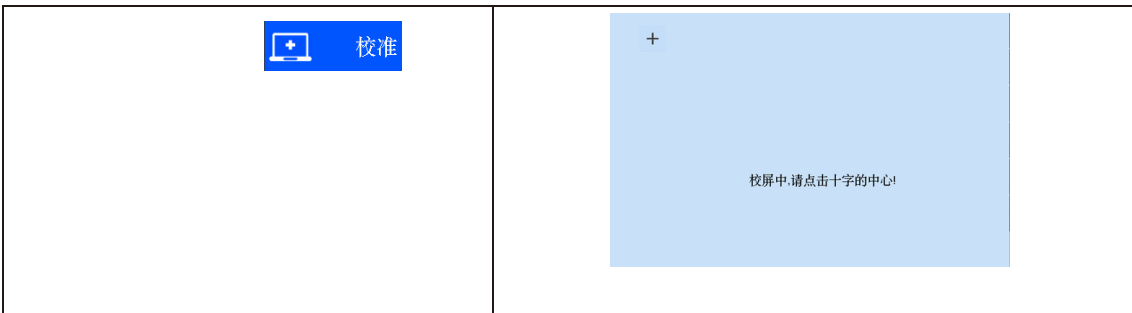

5.5

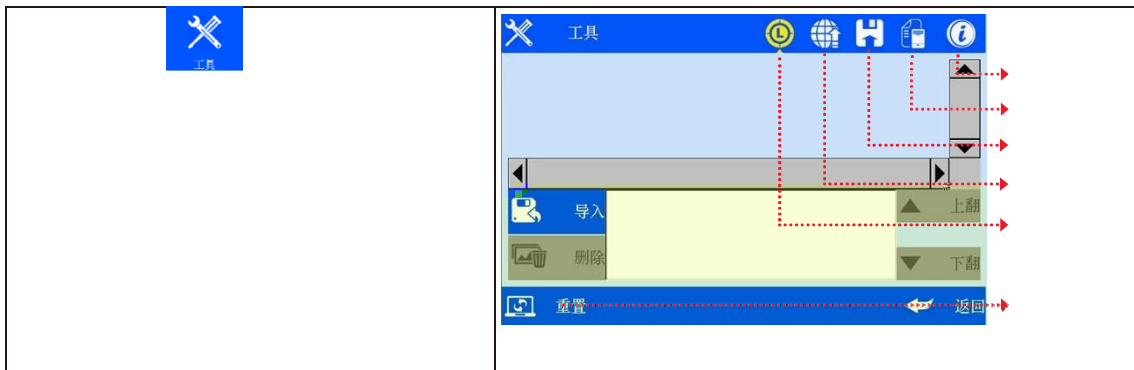

5.5.1

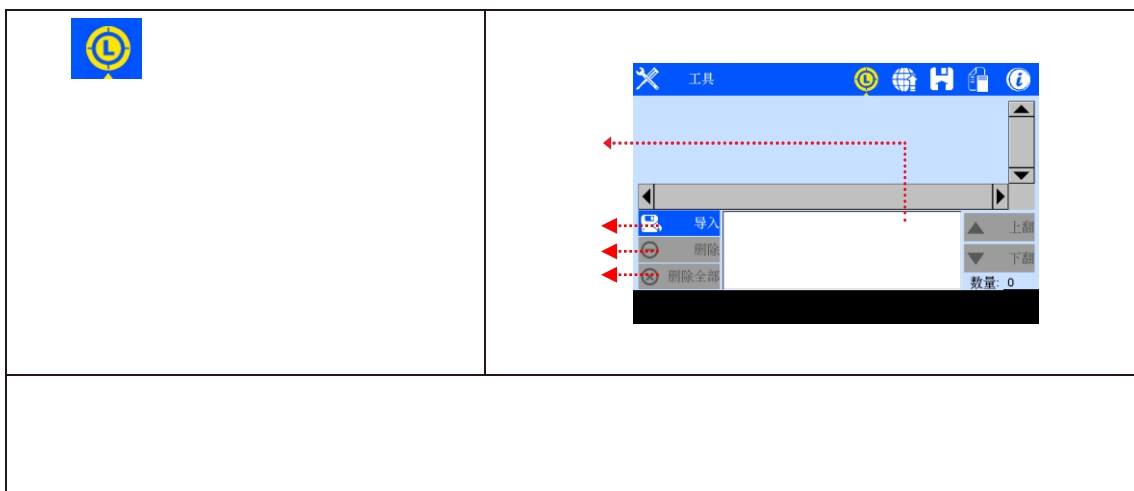

5.5.2

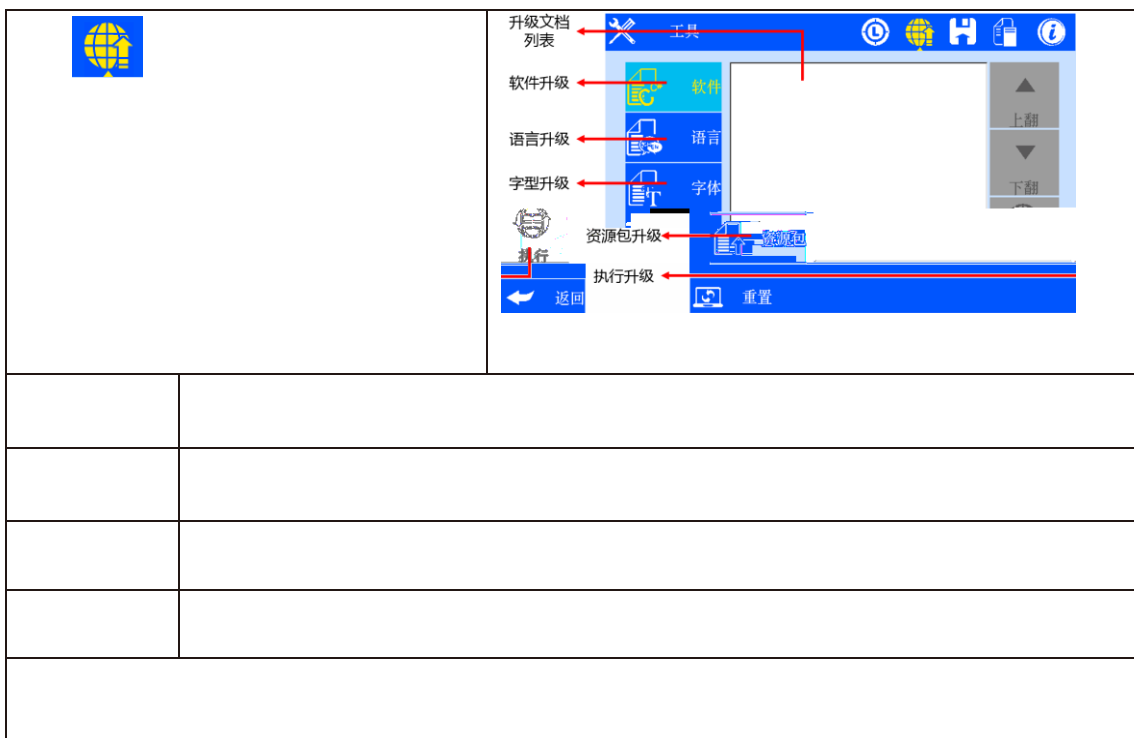

5.5.3

5.5.4

5.5.5

--	--

5.6

5.7

6.1

6.2

7.2